

Article number: 0106049

Description: Retaining ring JV 32

Measures

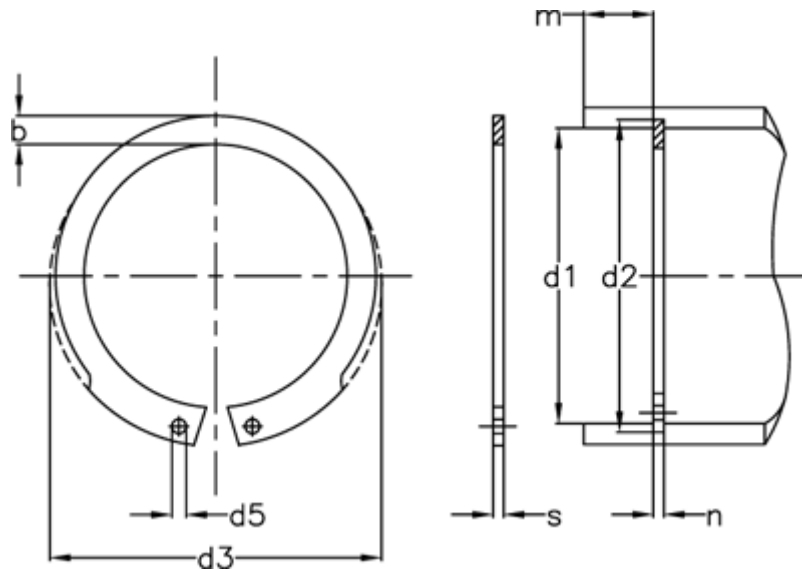

AN mm ²	= 42	FRg kN	= 4.9	tol	= 0.1
b	= 3.3	FR kN	= 14.1	tol	= -0.06
d1	= 32	g	= 1.0	tol	= +0,50-0,25
d2	= 33.7	K kN-mm	= 27.4	tol	= +0,25
d3	= 34.4	m min	= 1.30	Tong	= ZGJ-1
d5 min	= 1.5	Nominal drive	= 2.5	Weight kg/1000	= 2.05
Description	= JV 32	s	= 1.20		
FN kN	= 7.00	t	= 0.85		